

*Cellular Shades*

# MOTORIZED SKYLIGHT

Simplicity with rechargeable batteries



# GETTING STARTED

A few simple tools are required:

- Measuring tape
- Power drill, drill bits
- 1/4" Hex head and/or Phillips driver bit
- Pencil
- Rubbing Alcohol (if mounting solar panel to glass)

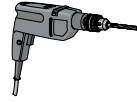

Additional fasteners other than those sent with your shade may be required depending on the mounting surface. Wallboard and plaster require the use of anchors such as expansion or toggle bolts. Brick, tile or stone need special plugs and drill bits. Remember to always pre-drill holes in wood to avoid splitting.

PN: CS4051

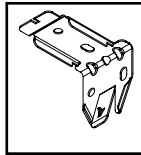

**Mounting  
Bracket**

PN: 20201012

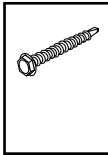

**1 1/4" Hex  
Head  
Bracket  
Screw**

PN: CS5201

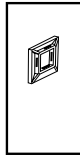

**Cable Tie  
Mounting  
Base**  
(included if  
solar panel  
ordered)

PN: CWV4024

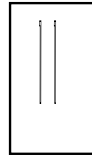

**Cable  
Ties**  
(included if  
solar panel  
ordered)

## BATTERY PACK

Shades 20" wide and wider have the rechargeable battery inside the head rail.

Shades under 20" wide require the rechargeable battery to be mounted on the back of the head rail. This requires an additional 1/2" clearance for mounting.

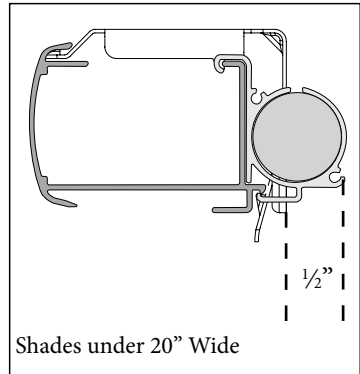

# STEP 1: DETERMINE PLACEMENT OF BRACKETS & SOLAR PANEL (if ordered)

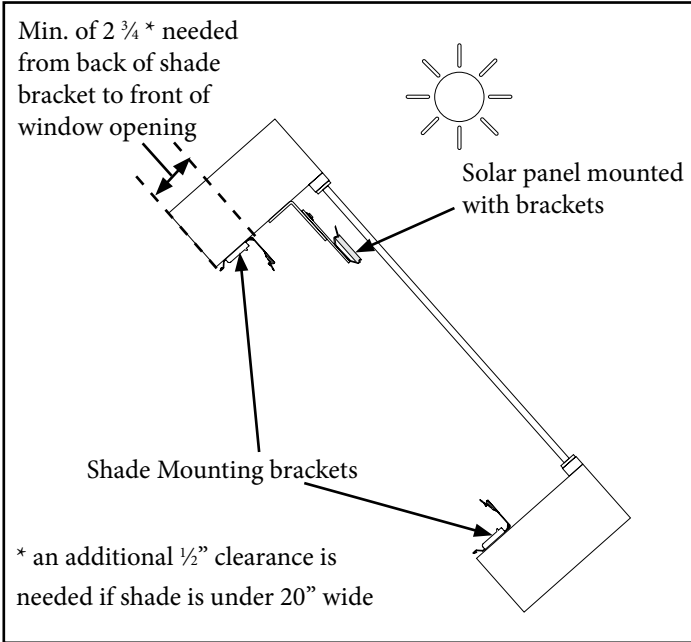

Solar Panel Mounted with Bracket

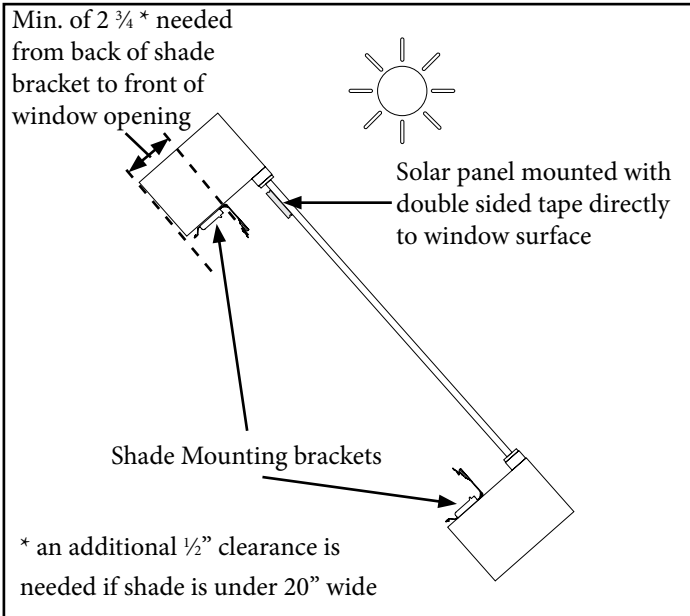

Solar Panel Mounted Directly to Glass

## STEP 2: BRACKET INSTALLATION

Shades are shipped with the required number of brackets for proper installation. End brackets should be located approximately 3" from either end. Depending on the width of the shade, additional brackets may be necessary, evenly spaced between the two end brackets.

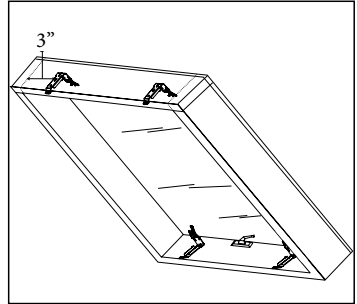

Using the installation bracket as a template, measure to the edge of the bracket and mark the hole locations with a pencil for drilling. When mounting brackets, make sure they are in line.

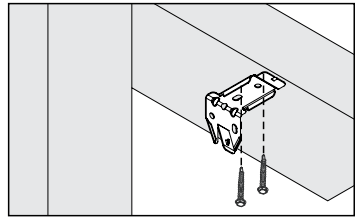

## STEP 3: INSTALL SOLAR PANEL (IF NOT USING SOLAR PANEL SKIP TO STEP 4)

The solar recharge unit should be placed where it gets the maximum amount of sunlight per day. **In most cases this can be achieved by mounting the unit directly to the glass with double sided tape.**

Brackets are provided if attaching to the glass is not possible.

The brackets may be mounted several different ways depending on the application (window depth, window width, etc.).

The unit requires 19" minimum window width to mount horizontally.

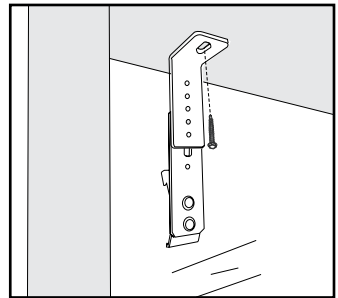

Bottom portion of the bracket may be lowered if needed for more sun exposure.

Bracket can be mounted behind or next to shade mounting bracket.

Note: only two of the holes are threaded.

## INSTALL SOLAR RECHARGE UNIT

Remove the clear protective sheet from the solar panel glass.

### Tape Method

Cut the tape (part # MI051045) to fit inside the white border as shown. Clean the ends of the solar panel where the tape will go with rubbing alcohol. When dry, remove the release liner from one side of the double sided tape and adhere them to face of the panel. Make sure to put the tape on the face (black side) of the panel.

Clean the window surface with rubbing alcohol. When dry, remove the release liners and attach the solar panel to the glass, pressing firmly to adhere.

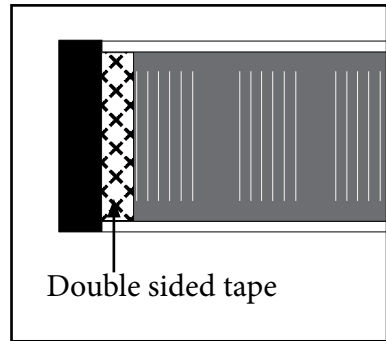

### Bracket Method

If using brackets, set the bottom groove of the unit onto the bottom bracket hook. Then press the top of the unit until it snaps into place.

If space is limited it may be easier to attach the brackets to the solar unit before screwing the brackets in place.

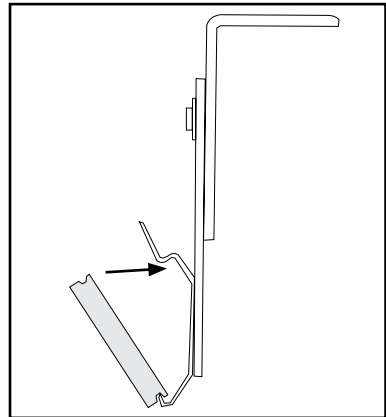

## STOP!

This booklet has instructions for 3 remote styles.

Determine which remote you have before proceeding.

TEAR OUT CENTER SPREAD FOR ILLUSTRATIONS OF EACH REMOTE FOR EASY REFERENCE.

### STEP 4: LINK REMOTE

#### 5 CHANNEL REMOTE

This remote control has 5 channels. Before linking the remote, determine which shade(s) you want on which channel. All shades linked to a remote will also automatically be programmed to the "ALL" channel.

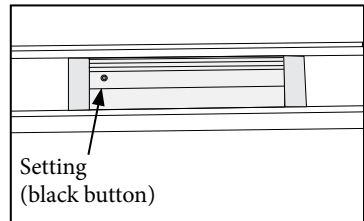

It is recommended to only link one shade per channel unless it is absolutely necessary to group shades other than the "all" channel. This simplifies adjusting limits and setting favorites.

Remove plastic film from the front of the remote.

If battery is not already installed in the remote follow the instructions on page 25.

1. Select the channel that you want to program using the **CHANNEL** selector buttons.
2. Press the **SETTING** button on the motor until the motor starts to beep. Release the button immediately after the beeps start. The motor will make 4 fast beeps followed by 5 long beeps. Press the **CONFIRM** button on the remote anytime during the series of long beeps. It must be pressed before the last long beep. The motor will respond with 3 fast beeps confirming that the shade has been linked.
3. Repeat steps 1-2 to program the rest of the channels.

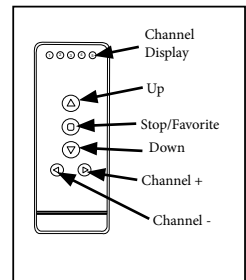

5 Channel Remote (front)

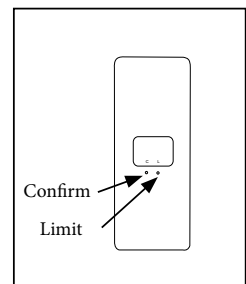

5 Channel Remote (back)

## TIMER REMOTE

This remote control has 6 channels. Before linking the remote, determine which shade(s) you want on which channel. All shades linked to a remote will also automatically be programmed to the “ALL” channel.

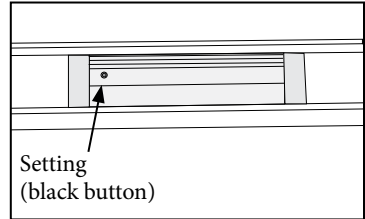

**It is recommended to only link one shade per channel** unless it is absolutely necessary to group shades other than the “ALL” channel. This simplifies adjusting limits and setting favorites.

Remove plastic film from the front of the remote.

If battery is not already installed in the remote follow the instructions on page 25.

**Turn the remote on by tapping any button. Then, tap the MODE button until you see “MANUAL” in the display.**

1. Select the channel that you want to program using the **CHANNEL** selector button. The button will scroll through channels in ascending order only. The remote will go back to channel 1 after all channels are displayed.

2. Press the **SETTING** button on the motor until the motor starts to beep. Release the button immediately after the beeps start. The motor will make 4 fast beeps followed by 5 long beeps. Press the **CONFIRM** button on the remote anytime during the series of long beeps. It must be pressed before the last long beep. The motor will respond with 3 fast beeps confirming that the shade has been linked.

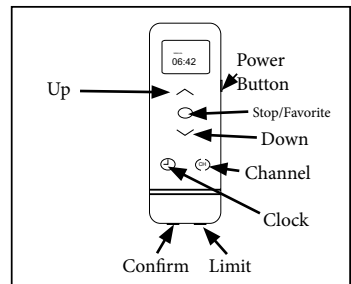

**Timer Remote**

3. Repeat steps 1-2 to program the rest of the channels.

## 14 CHANNEL REMOTE

**Important: Please read through this section completely before beginning.**

This remote control has 14 channels. Before linking the remote, determine which shade(s) you want on which channel. All shades linked to a remote will also automatically be programmed to the “ALL” channel.

**It is recommended to only link one shade per channel** unless it is absolutely necessary to group shades other than the “ALL” channel. This simplifies adjusting limits and setting favorites.

The 14 Channel remote may also be used to operate top down-bottom up cellular shades. **You can not mix a standard bottom up only shade and a TD/BU shade on the same channel.**

Remove plastic film from the front of the remote.

If battery is not already installed in the remote follow the instructions on page 25.

1. Select the channel that you want to link the shades to, using the **CHANNEL** selector button. The button will scroll through channels in ascending order only. The remote will go back to channel 1 after channel AL. See next page to disable unused channels.

2. Confirm that the channel selected is set for bottom up only shades by looking to see if a number 1, 2 or 3 shows in the left of the display. If a number is shown, deactivate the Top Down/Bottom Up function for that channel by pressing the **RAIL SELECTOR** and **DOWN** buttons at the same time until the rail selector number disappears from the left side of the screen.

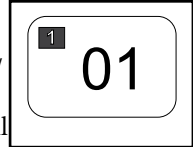

3. Press the **SETTING** button on the motor until the motor starts to beep. Release the button immediately after the beeps start. The motor will make 4 fast beeps followed by 5 long beeps. Press the **CONFIRM** button on the remote anytime during the series of long beeps. It must be pressed before the last long beep. The motor will respond with 3 fast beeps confirming that the shade has been linked.

4. Repeat steps 1-3 to link remaining shades to the rest of the channels.

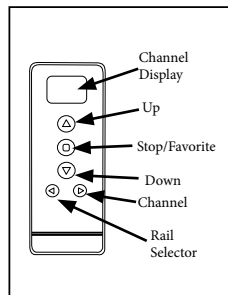

14 Channel Remote (front)

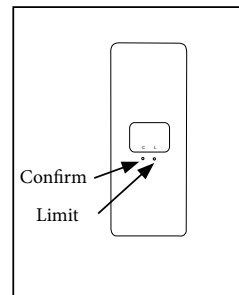

Remote (back)



## DISABLING EXCESS CHANNELS ON 14 CHANNEL REMOTE

The 14 channel remote has the option of turning off unused channels, making channel selection easier.

Press and hold both UP and DOWN buttons for 3 seconds until 00 Channel displays. Release the buttons and the 00 will start to flash.

Press the UP or DOWN button to select the required number of channels (between 1-14).

Press and hold the CHANNEL and RAIL selector buttons at the same time to confirm selection. The display will go back to channel 01.

Follow the same process if you need to re-add channels.

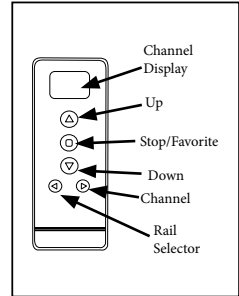

14 Channel Remote (front)

## STEP 5: INSTALL TOP RAIL

Start with the top rail/fabric assembly. The top rail is the rail with the motor in it.

Position the rail with the front lip (A) resting on the hooks of all the brackets. Push the rail firmly up and toward the window until the groove on the rail snaps into place, (B) as shown.

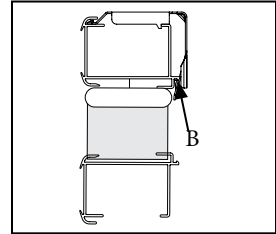
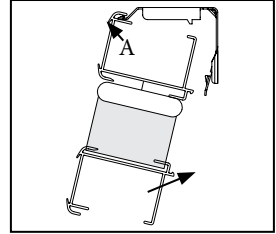

## STEP 6: ATTACH SOLAR PANEL (IF NOT USING SOLAR PANEL SKIP TO STEP 7)

After the top rail is installed, plug the solar unit into the battery recharge port.

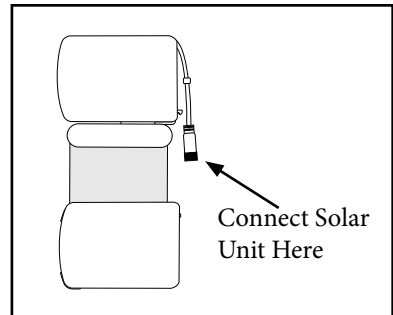

Use the included cable ties and cable tie mounting base to bundle any excess wires.

The mounting base may be adhered to the back of the head rail or any other convenient surface.

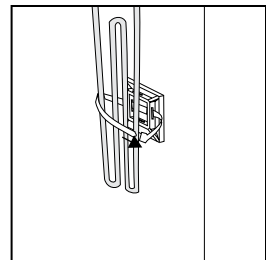

## STEP 7: INSTALL BOTTOM RAIL

Use the remote to lower the bottom rail all the way down so that it can be attached to the mounting brackets.

### 5 CHANNEL REMOTE

Select the desired channel with the **CHANNEL** buttons. The channel indicator light will illuminate the channel that is on. If all 5 lights are lit the remote will control all 5 channels at once.

Press the **DOWN** button to lower the shade.

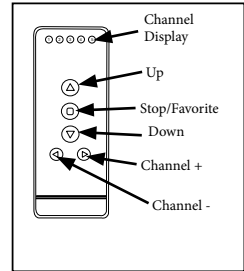

5 Channel Remote (front)

### TIMER REMOTE

Press any button to turn on the remote.

The timer remote will function like a standard remote while in manual mode.

Tap the **MODE** button until you see "MANUAL" in the display.

Select the desired channel with the **CHANNEL** buttons. The channel will show in the display screen. If all 6 channel numbers are shown, the remote will control all 6 channels at once.

Press the **DOWN** button to lower the shade.

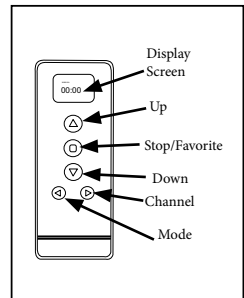

Timer Remote (front)

### 14 CHANNEL REMOTE

Select the desired channel with the **CHANNEL** buttons. The channel will show in the display screen. If an "AL" is displayed the remote will control all 14 channels at once.

Press the **DOWN** button to lower the shade.

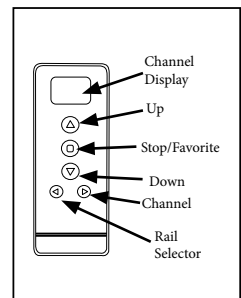

14 Channel Remote (front)

Position the rail with the front lip (A) resting on the hooks of all the brackets. Push the rail firmly down and toward the window until the groove on the rail snaps into place, (B) as shown.

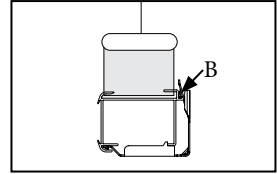
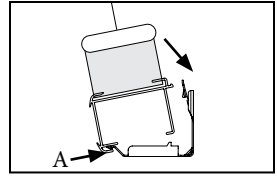

## STEP 8: INSTALL TRACKS

Place the track against the front of the top and bottom rails. Attach the track with the screws provided. Space the screws no more than 12" apart.

Follow the same procedure for the other track. Make sure that the 2 tracks are parallel to each other.

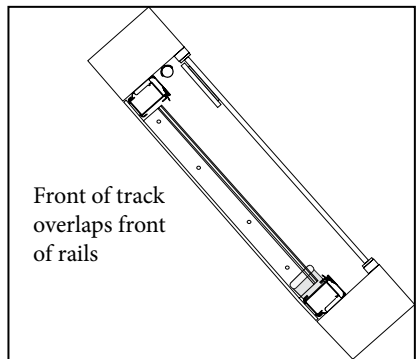
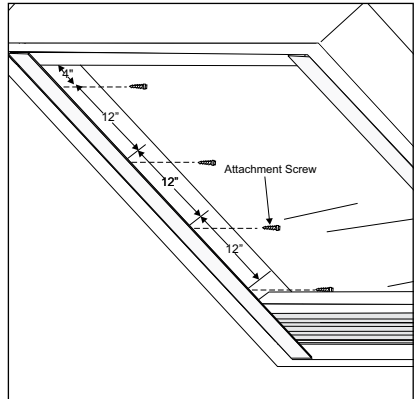

# OPERATION

## 5 CHANNEL REMOTE

Select the desired channel with the **CHANNEL** buttons. The channel indicator light will illuminate the channel that is on. If all 5 lights are lit, the remote will control all 5 channels at once.

Tapping the **UP** or **DOWN** buttons for less than 2 seconds will move the shade in short steps. Holding the **UP** or **DOWN** buttons down for more than 2 seconds before releasing will operate the shade in the faster standard speed.

Press the **UP** or **DOWN** buttons to raise or lower the shade.

Press the **STOP** button to stop the shade anywhere along the travel.

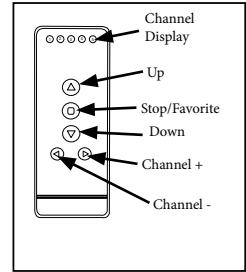

5 Channel Remote (front)

## TIMER REMOTE

Shades can be manually operated while in manual mode. Tap the **MODE** button until you see "MANUAL" in the display.

Select the desired channel with the **CHANNEL** buttons. The channel will show in the display screen. If all 6 channel numbers are shown, the remote will control all 6 channels at once.

Press the **UP** or **DOWN** buttons to raise or lower the shade.

Press the **STOP** button to stop the shade anywhere along the travel.

Note: The timer remote does not have fine adjustment capability (jog function).

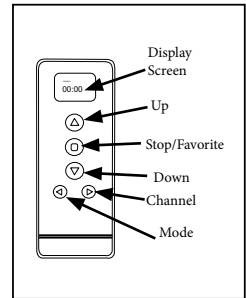

Timer Remote



Timer Remote Display Screen

# OPERATION

## 14 CHANNEL REMOTE

Select the desired channel with the **CHANNEL** button.

Tapping the **UP** or **DOWN** buttons for less than 2 seconds will move the shade in short steps. Holding the **UP** or **DOWN** buttons down for more than 2 seconds before releasing will operate the shade in the faster standard speed. Press the **UP** or **DOWN** buttons to raise or lower the shade.

Press the **STOP** button to stop the shade anywhere along the travel.

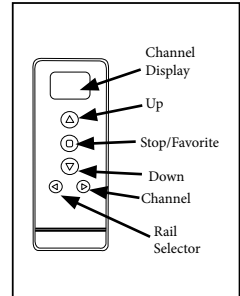

14 Channel Remote (front)

## TO DE-ACTIVATE THE JOG FUNCTION

The remote comes pre-set with the jogging function activated. Follow the directions below if you would like to de-activate it.

Press down and up on the back cover to slide it approximately  $\frac{1}{4}$  inch.

Carefully remove the back cover of the remote.

Slide the switch from the H position to the R position.

Replace the back cover of the remote making sure that the rubber piece that goes over the confirm and limit buttons stays in place.

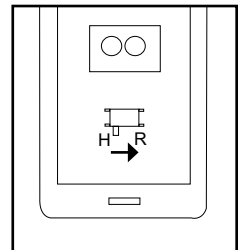
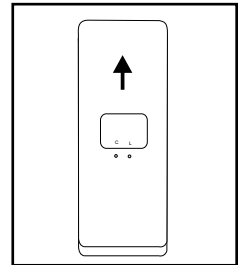

# **REMOVE THIS PAGE FOR EASY REFERENCE**

**ILLUSTRATIONS OF THE FOLLOWING REMOTES:**

**5 CHANNEL REMOTE**

**TIMER REMOTE**

**14 CHANNEL REMOTE**

# 5 Channel Remote

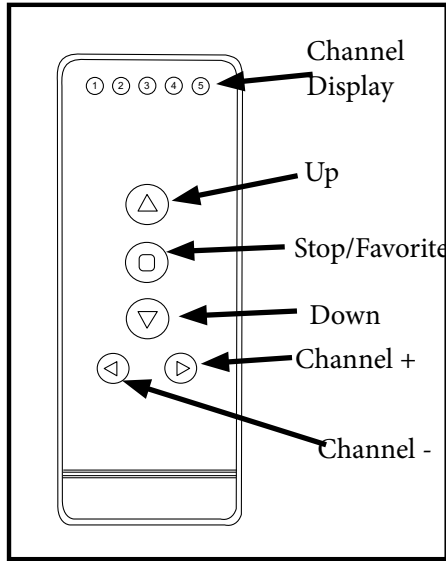

**FRONT**

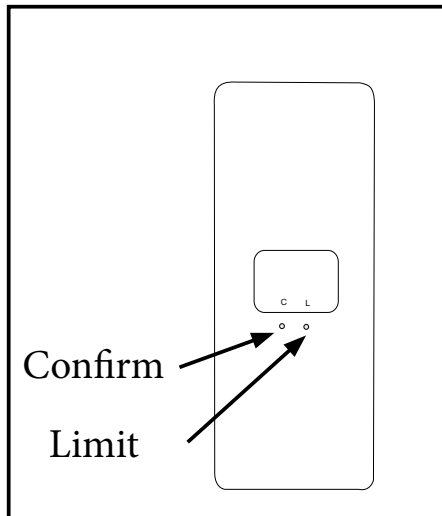

**BACK**



# 6 Channel Timer Remote

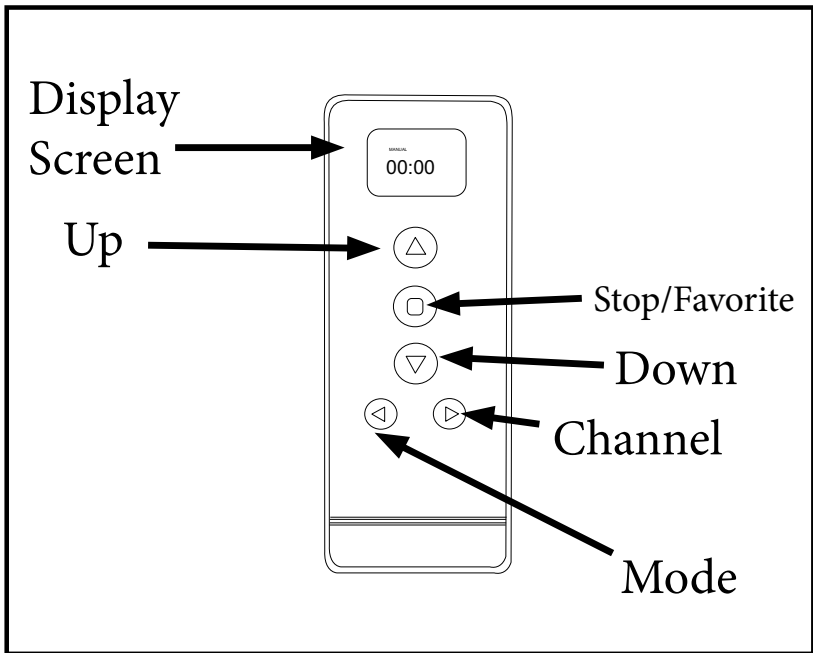

**FRONT**

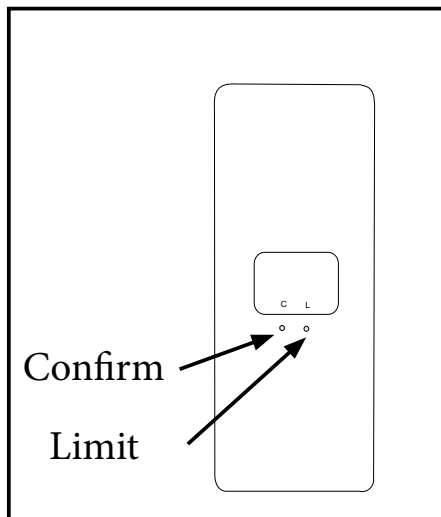

# 14 Channel Remote

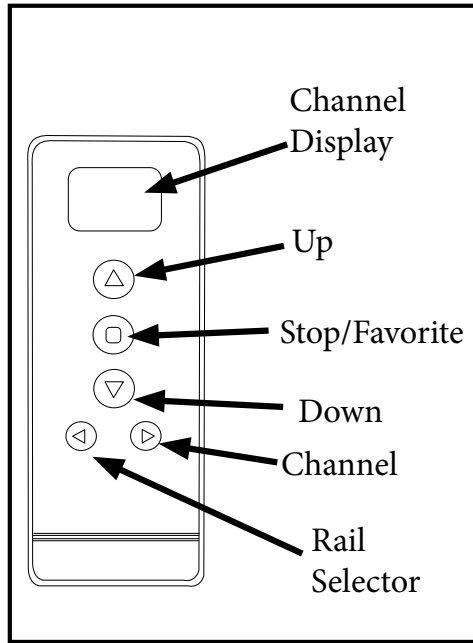

**FRONT**

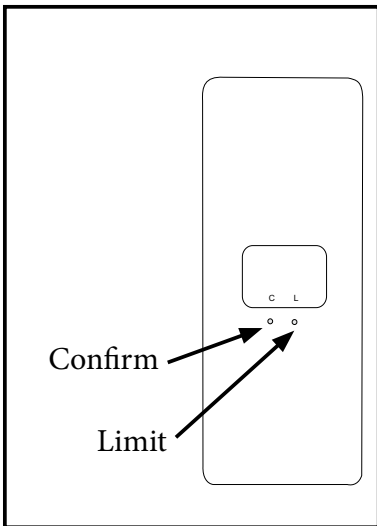

**BACK WITH COVER**

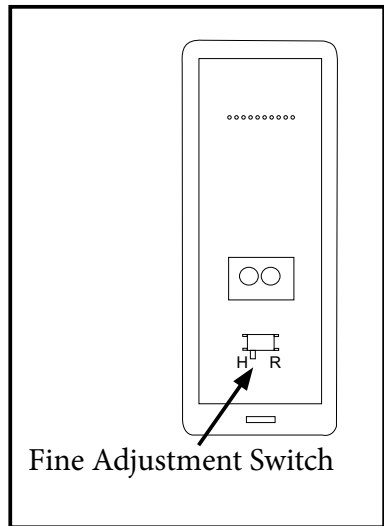

**BACK WITHOUT COVER**

## ADJUST MOTOR LIMITS (IF DESIRED)

**If using a timer remote, tap the MODE button until you see “MANUAL” in the display.**

The lower and upper limits have been set at the factory. If you need to make adjustments to the limits, follow the instructions below.

Please Note: When clearing the factory set limits, both the upper and lower limits will need to be reset.

Use the **CHANNEL** buttons to select the channel for the shade that needs to be adjusted. Then follow the directions below.

When adjusting one shade any other shades on that channel need to be temporarily unplugged.

To unplug a shade, remove the shade from the window (see page 25) and unplug the battery pack from the motor. Repeat for all other shades on that channel.

Follow the limit setting instructions on next page and then reattach plug on “turned off” shades.

## LOWER LIMIT

Hold the **LIMIT** button until the shade starts beeping.

After the shade stops beeping, use the **DOWN** button to lower the shade. Press stop when the shade is near the desired lower limit.

Use the **UP** and **DOWN** buttons to adjust the length more accurately.

Hold the **CONFIRM** button until the shade makes a series of short beeps. This locks in the lower limit.

## UPPER LIMIT

Use the **UP** button to raise the shade. Press stop when the shade is near the desired upper limit.

Use the **UP** and **DOWN** buttons to adjust the upper limit more accurately.

Hold the **CONFIRM** button until the shade makes a series of short beeps. This locks in the upper limit.

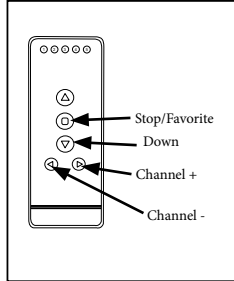

5 Channel Remote (front)

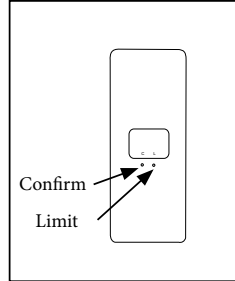

Back of all Remotes

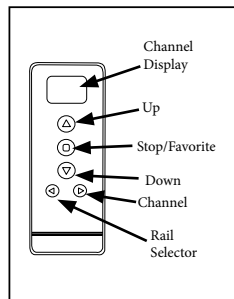

14 Channel Remote (front)

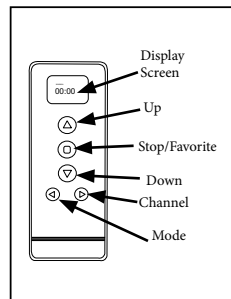

Timer Remote (front)

# FAVORITE POSITION

## SETTING A FAVORITE POSITION

Use the **UP** or **DOWN** buttons to position the shade at the desired “favorite” position. While holding the **LIMIT** button, quickly press and hold the **UP** button. Release both buttons when the shade makes a series of short beeps.

## USING A FAVORITE POSITION

With the shade at either the upper or lower limit, simply press the **STOP/FAVORITE** button to bring the shade to the “favorite” position. To go to the “favorite” position from any other location, make sure the shade has been stopped for at least three seconds before pressing the **STOP/FAVORITE** button.

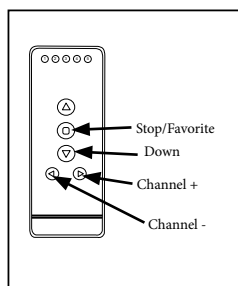

5 Channel Remote (front)

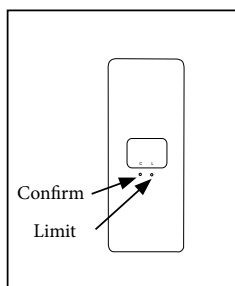

Back of all Remotes

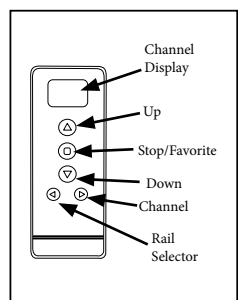

14 Channel Remote (front)

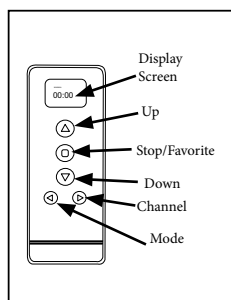

Timer Remote (front)

## CHANGING A FAVORITE POSITION

Use the **UP** or **DOWN** buttons to position the shade at the desired “favorite” position. While holding the **LIMIT** button, quickly press and hold the **UP** button. Release both buttons when the shade makes a series of short beeps.

To erase a “favorite” position, bring the shade to the **upper** limit. Press and hold the **LIMIT** button on the back of the remote, then press and hold the **UP** button. Release both buttons when the shade makes a series of short beeps.

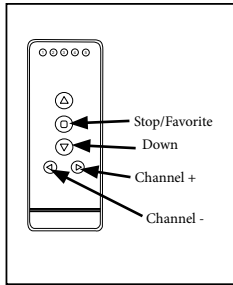

5 Channel Remote (front)

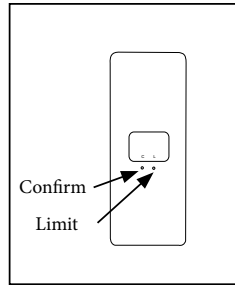

Back of all Remotes

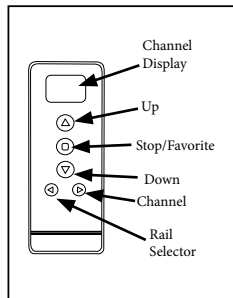

14 Channel Remote (front)

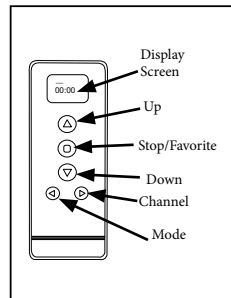

Timer Remote (front)

# ADVANCED PROGRAMMING

## REPLACE ORIGINAL REMOTE, ADD ADDITIONAL REMOTE OR ADD SHADE TO AN ADDITIONAL CHANNEL

1. Select the channel that you want to program using the **CHANNEL** selector button.
2. Press the **SETTING** button on the motor until the motor starts to beep. Release the button immediately after the beeps start. The motor will make 4 fast beeps followed by 5 long beeps. Press the **CONFIRM** button on the remote anytime during the series of long beeps. It must be pressed before the last long beep. The motor will respond with 3 fast beeps confirming that the shade has been linked.

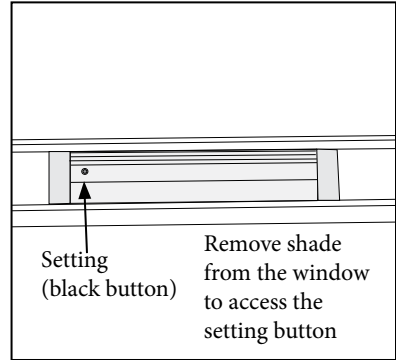

3. Repeat steps 1-2 to program the rest of the channels on a multi-channel remote.
4. All shades linked to a remote will also automatically be programmed to the "ALL" channel.

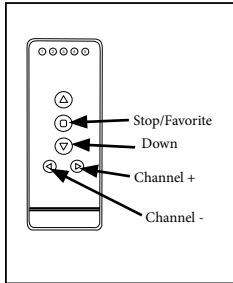

5 Channel Remote (front)

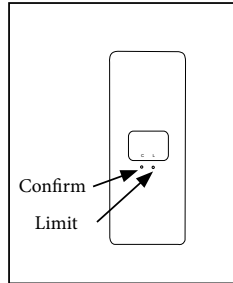

Back of all Remotes

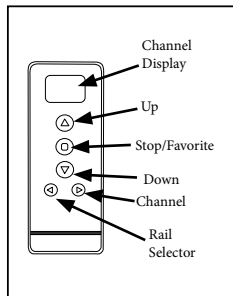

14 Channel Remote (front)

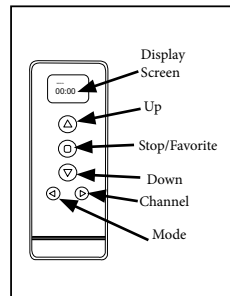

Timer Remote (front)

# REMOVE A SHADE FROM A REMOTE OR CHANNEL AND LINK IT TO A DIFFERENT REMOTE OR CHANNEL

## Unlink the motor from the remote

1. Select the Channel that you want to unlink.

**Please note:** All shades on that channel will be unlinked. If you have shades on a channel that you do not want to unlink you must temporarily unplug the motor from the battery pack (inside head rail).

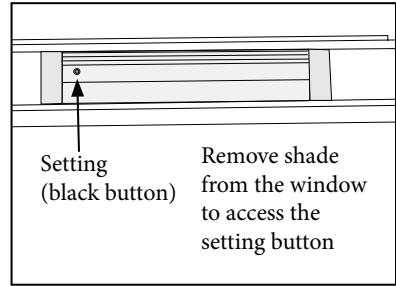

2. Press and release the **CONFIRM** button. Continue to press and release until the motor beeps 8 times.

All shades previously linked to selected channel will now be unlinked.

## Link the motor to the new remote or channel

1. Follow the steps for replacing the remote on page 18.

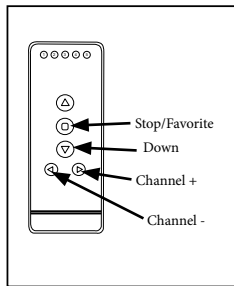

5 Channel Remote (front)

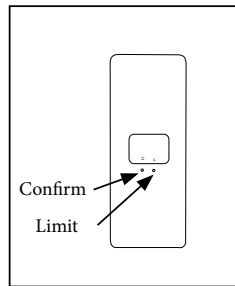

Back of all Remotes

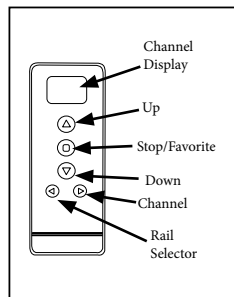

14 Channel Remote (front)

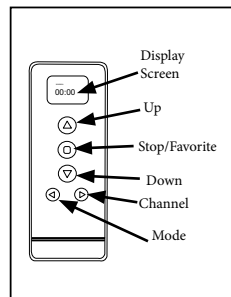

Timer Remote (front)



# PROGRAMMING TIMER REMOTE

## SETTING CLOCK

Press any button to turn on the remote.

Tap the **MODE** button until you see “MANUAL” in the display.

Push and hold the **LIMIT** button. While holding the **LIMIT** button, push the **MODE** button for 3 seconds and release. The hour digits will flash.

Use the **UP** and **DOWN** buttons to set the current hour. **NOTE:** Time is in 24 hour format (military time). For example: 1:00 PM will be displayed as 13:00.

Press **CHANNEL** button to confirm hour and advance to minutes.

Use the **UP** and **DOWN** buttons to set the current minute.

Press **CHANNEL** button to confirm minute and advance to day.

Use the **UP** and **DOWN** buttons to set the current day.

Hold the **MODE** button for 3 seconds. Display will flash and then display the current time and day.

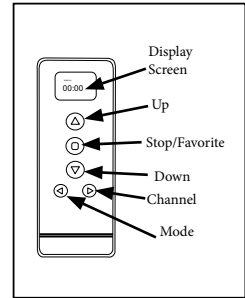

6 Channel Timer Remote  
(front)

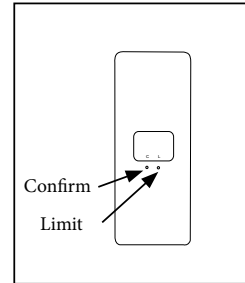

Remote (back)

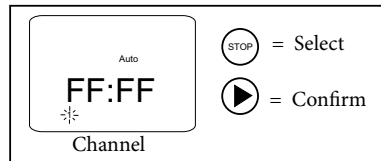

## SETTING TIMER SCHEDULES

The timer remote allows up to 18 different timer schedules. Each timer schedule can be set for multiple channels and days, but only one function can happen at each time.

Press any button to turn on the remote.

Tap the **MODE** button until you see “AUTO” in the display.

While holding the **LIMIT** button, push the **MODE** button for 3 seconds and release. The time will flash, then display “NO 1” and the flash “FF:FF”. If you want to set a different timer schedule press **MODE** for 1 second to scroll through the schedules (NO 1, NO 2, NO 3 etc.). Unprogrammed schedules will display FF:FF.

Press **STOP** button and the channel number display along the bottom of the screen will flash.

Use the **STOP** button to select the channel and move on to the next one. Use the **UP** arrow to skip a channel and the **DOWN** arrow to back up. You must press **STOP** for each channel that you want to select. If the channel is still flashing, it has not been selected.

Press **CHANNEL** button to confirm channels and advance to day selection.

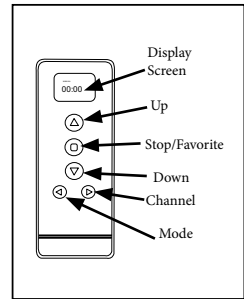

**6 Channel Timer Remote (front)**

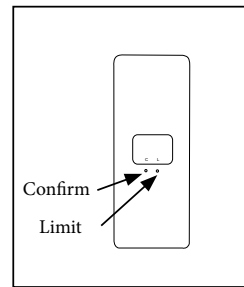

**Remote (back)**

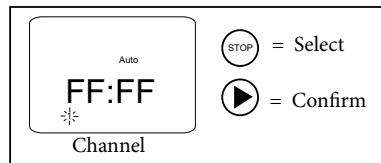

Use the **STOP** button to select the day and move on to the next one. Use the **UP** arrow to skip a day and the **DOWN** arrow to back up. You must press **STOP** for each day that you want to select. If the day is still flashing, it has not been selected.

Press **CHANNEL** button to confirm days and advance to hour selection.

Use the **UP** and **DOWN** buttons to set the hour. **NOTE:** Time is in 24 hour format (military time). For example: 1:00 PM will be displayed as 13:00.

Press **STOP** button to confirm hour and advance to minutes.

Use the **UP** and **DOWN** buttons to set the minutes.

Press **STOP** button to confirm minutes and advance to shade operation.

Shade operation symbols are to the right of the time. Use the **UP** and **DOWN** buttons to select the operation. ▲ will raise the shade, ▼ will lower the shade, ◆ will bring the shade to the favorite position.

Press **STOP** button to confirm operation.

Push the **MODE** button for 3 seconds and release. The display will flash to confirm settings are saved and advance to the next schedule. Repeat the steps above for each desired schedule.

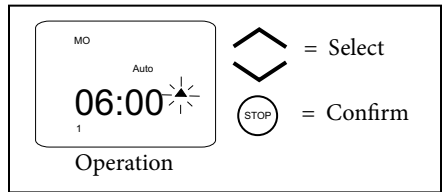
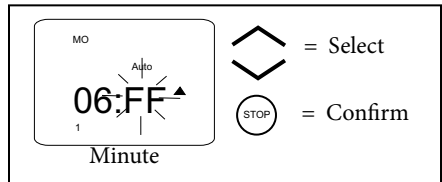
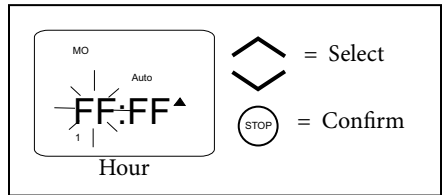
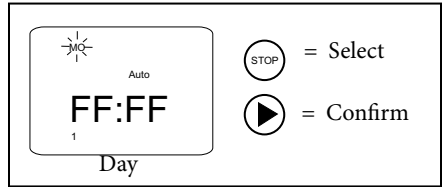

## IMPORTANT NOTES

- **Remote must be in “AUTO” mode for the set schedules to operate.** To return to “MANUAL” mode, tap the **MODE** button.
- When remote is in Auto mode, the display will alternate between the current time/day and the time/day/channel for the next upcoming schedule.
- To disable a schedule, simply reset the scheduled time to FF:FF.

## SAMPLE SCHEDULE

NO 1: CH1 & CH2, MO TU WE TH FR, 6:00, ▲

NO 2: CH1 & CH2, MO TU WE TH FR, 21:00, ▼

NO 3: CH1 & CH2, SA SU, 9:00, ▲

NO 4: CH1 & CH2, SA SU, 22:00, ▼

NO 5: CH3, MO TU WE TH FR SA SU, 10:00, ◆

NO 6: CH3, MO TU WE TH FR SA SU, 21:00, ▼

## EQUALIZATION - IF NECESSARY

Motorized Skylight Shades use a system that allows easy leveling of the moving rail. Use a flat head screwdriver or a coin (a quarter works best) to turn the adjustment screw to raise or lower that side of the moving rail. The adjustment screws are on the top of the moving rail. One quarter turn of the screw will move the moving rail up or down approximately  $\frac{1}{4}$ ". **Over-turning the adjustment screw (more than 1" of adjustment) can cause the cord to tangle or wedge inside the rail. The screw should turn easily - DO NOT FORCE.**

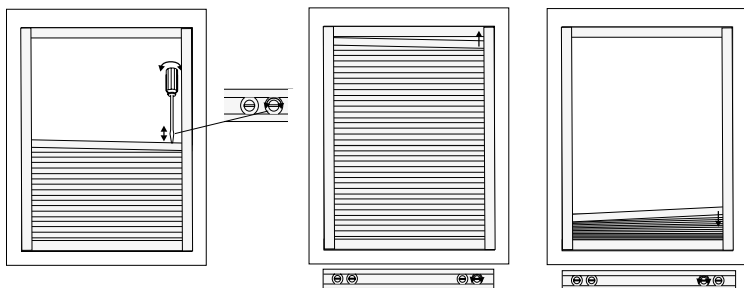

If the rail is uneven at the top, raise the low side with the outer adjustment screw.

If the stack is uneven at the bottom, lower the high side with the inner adjustment screw.

## CHARGING THE BATTERY

When the shade begins to operate slower than normal it is time to charge the battery.

Plug the 8.4v charger into the charging wire. The charging wire is attached to the back of the head rail at the right end. If a solar panel is being used, unplug it from the charging wire.

Plug the charger into an electrical outlet.

A red light on the charger indicates that the battery is charging.

Allow the batteries to charge until the light on the charger turns green. A typical charge cycle can take between 4-6 hours.

Do not leave the charger plugged in for more than 24 hours. This could prematurely age the battery.

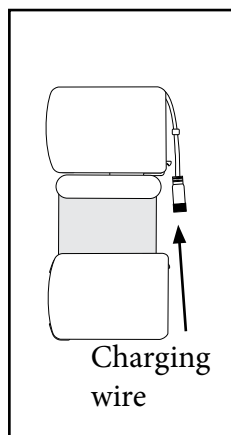

## REPLACING THE BATTERY IN THE REMOTE

Remove the battery tray from the remote by inserting a fingernail into the indentation on the back of the remote. To avoid the battery falling out of the remote, remove the tray while the remote is face up.

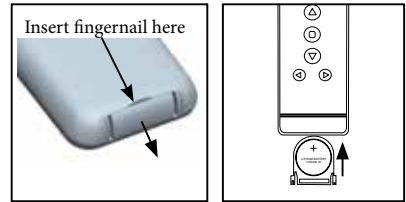

Insert the new battery (CR2430 lithium) into the battery tray so that the writing is facing up (positive up) when the remote is face up. Slide the tray back into the remote.

## SHADE REMOVAL

To remove a shade, first remove the side tracks. Then insert a screwdriver between the rail and the bottom back of the bracket (tab which extends out slightly from each bracket).

Gently pry the screwdriver to release the bracket from the rail. Take care not to damage the painted finish of the rail.

As you release the brackets, support the rail to keep it from falling.

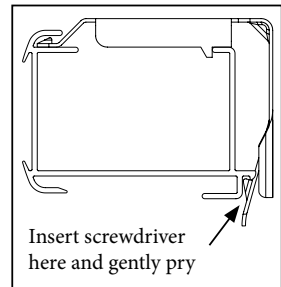

## CLEANING AND CARE

The shade fabric is easy to care for. Regular dusting with a feather duster or vacuum cleaner brush is recommended. Most stains can be blotted with a damp sponge and mild detergent. Before using anything stronger than mild detergent and lukewarm water, test an unobtrusive corner of the shade. If you have any questions, call your dealer for advice.

## TROUBLESHOOTING

<b>Problem</b>	<b>Solution</b>
The motor does not work and the shade is stuck in the closed position.	Carefully pull down on the moving rail enough to allow access. Follow solution below. If this is required, limits will need to be reset. See Adjust Motor Limits section for setting limits.
The motor does not work	<ol style="list-style-type: none"><li>1. Recharge Battery</li><li>2. If using a solar panel - be sure that the panel is facing the sun</li><li>3. If using a solar panel - there may have been a high draw (operating shade often) with limited sun exposure (multiple cloudy days). If this happens a DC charger may be purchased to give the rechargeable batteries in the shade a boost. Contact your dealer for a charger</li></ol>
The indicator light on the remote does not shine or the remote-controlling range becomes shorter	Replace the battery in the remote (CR2430)